



## **Hand towed Battery Pallet Stacker KBE 1500/3,0**

### **Standard equipment**

- Light duty application
- Hand towed and Battery powered Lifting/Lowering
- Capacity – **1500 kg**
- Lifting height – **3,0 m**
- DC pump motor – 2 kW
- Traction Battery 2x12V/90 Ah C5
- Automatic on-board charger 24V/15 A
- Battery discharge indicator
- Load backrest
- Steering device
- Castor wheels – Polyurethane (right Drive side – with brake)
- Load side - Tandem rollers Polyamide/ as standard
- Robust Two stage mast with central cylinder

### **Optional equipment**

- Modified Chassis (Straddle legs version)

## Hand towed Battery Operated Pallet Stacker KBE 1500/3,0

Type sheet for industrial Trucks according to VDI 2198

		<b>VENI</b>			
Characteristics	1.1	Manufacturer			<b>KBE 1500/3,0</b>
	1.2	Manufacturer's type designation			Battery
	1.3	Power unit			Hand towed
	1.4	Operation			Battery lifting/lowering
	1.5	Load capacity	<b>Q</b>	(kg)	<b>1500</b>
	1.6	Load centre	<b>c</b>	(mm)	600
	1.8	Axle centre to fork face	<b>x</b>	(mm)	690
	1.9	Wheelbase	<b>y</b>	(mm)	1088
	Weight	2.1	Service weight incl. battery		(kg)
Wheels/tyres	3.1	Tyres front/rear (Polyurethane/PU, Polyamide/PA)			PU/PA
	3.2	Tyre size, front		(mm)	D 200x50
	3.3	Tyre size, rear		(mm)	D 82x70
	3.5	Wheels, number front / rear (x=driven)		(mm)	2/4
	3.6	Track width, front	<b>b<sub>10</sub></b>	(mm)	688
	3.7	Track width, rear	<b>b<sub>11</sub></b>	(mm)	400
Dimensions	4.2	Height, mast lowered	<b>h<sub>1</sub></b>	(mm)	2000
	4.3	Free lift	<b>h<sub>2</sub></b>	(mm)	100
	4.4	Lift	<b>h<sub>3</sub></b>	(mm)	2910
	4.5	Height, mast extended	<b>h<sub>4</sub></b>	(mm)	3405
	4.9	Height of tiller in drive position min./max.	<b>h<sub>14</sub></b>	(mm)	1160
	4.15	Fork height, lowered	<b>h<sub>13</sub></b>	(mm)	90
	4.151	Fork height, lifted	<b>h<sub>3</sub>+h<sub>13</sub></b>	(mm)	3000
	4.19	Overall length	<b>l<sub>1</sub></b>	(mm)	1800
	4.20	Length to fork face	<b>l<sub>2</sub></b>	(mm)	650
	4.21	Overall width	<b>b<sub>1</sub></b>	(mm)	800
	4.22	Fork dimensions	<b>s/e/l</b>	(mm)	55/175/1150
	4.25	Overall forks width	<b>b<sub>5</sub></b>	(mm)	560
	4.32	Ground clearance, centre of wheelbase	<b>m<sub>2</sub></b>	(mm)	35
4.34	Aisle width with pallet 800x1200 mm along forks	<b>Ast</b>	(mm)	2410	
4.35	Turning radius	<b>Wa</b>	(mm)	1700	
4.36	Internal turning radius	<b>b<sub>13</sub></b>	(mm)	840	
Performance	5.2	Lifting speed, with/ without load		(m/s)	0.102/0.130
	5.3	Lowering speed, with/ without load		(m/s)	0.112/0.092
Drive	6.2	Lift motor rating S3 15%		(kW)	2.0
	6.4	Battery voltage/ rated capacity C5		(V/Ah)	2x12-24/90

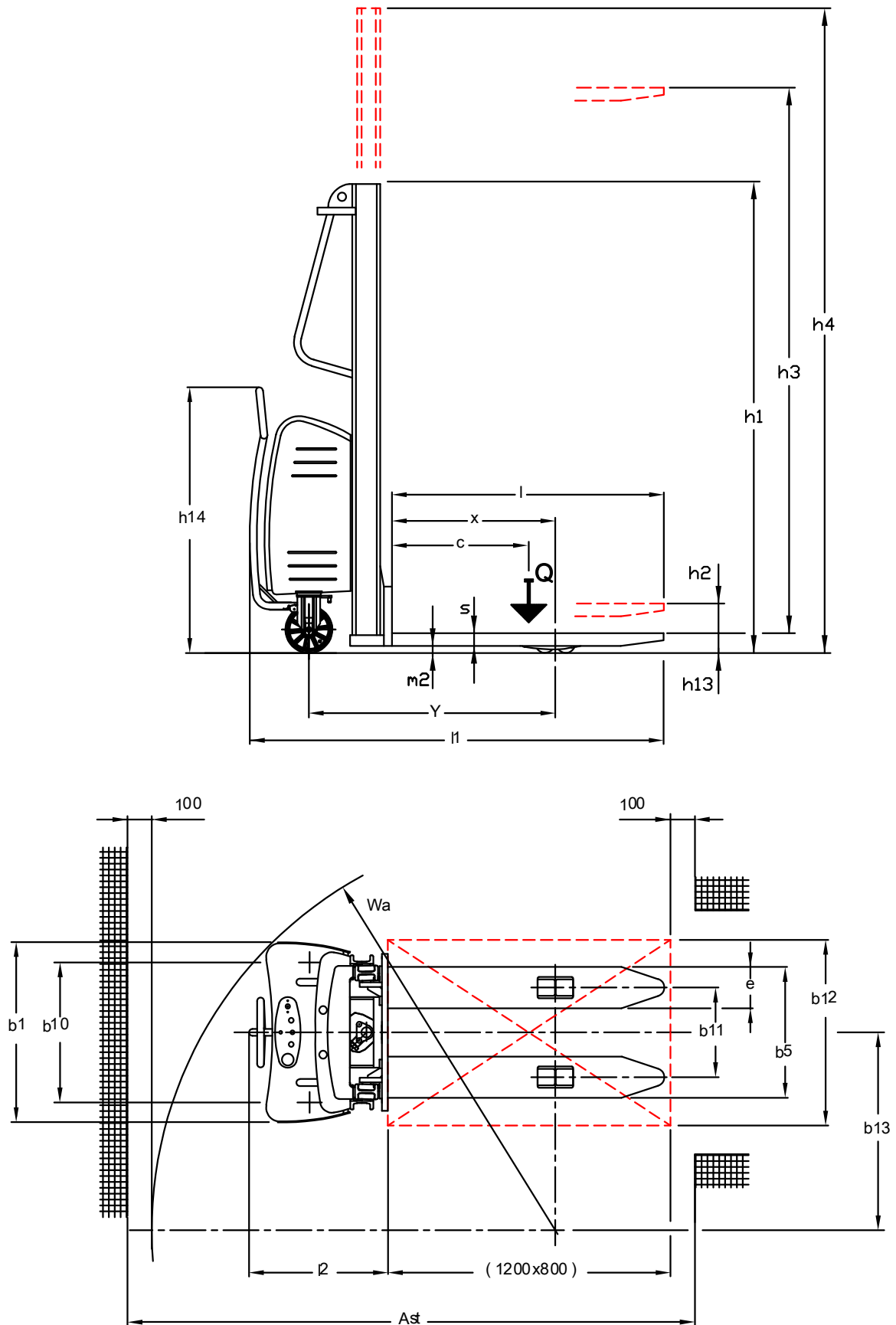

VDI 2198 - Four wheel Forklift Truck top view,  
reduced load width -  $b_{12} / 2 \leq b_{13}$